



tapo

tapo

# User Manual

Robot Vacuum & Mop  
+ Smart Auto-Empty Dock

\*Images may differ from actual products.

©2024 TP-Link 7106511333 REV1.0.0



# Contents

<b>Safety Information</b> .....	<b>1</b>
<b>Package Contents</b> .....	<b>1</b>
<b>Overview</b> .....	<b>2</b>
Robot Vacuum .....	2
Auto-Empty Dock .....	4
<b>Setup and Use</b> .....	<b>5</b>
Position the Dock .....	5
Remove Protective Film & Protective Strips .....	6
Turn On Robot Vacuum .....	6
Charge Robot Vacuum .....	6
Download Tapo App and Set Up .....	7
Cleaning .....	8
Mopping .....	9
<b>Care and Maintenance</b> .....	<b>10</b>
Empty the Dustbin .....	11

Clean the Filter .....	11
Clean the Main Brush .....	12
Clean the Side Brush .....	12
Clean the Caster Wheel .....	13
Clean Main Wheels .....	13
Clean the LiDAR and Sensors .....	14
Clean the Charging Contacts .....	14
Replace the Bag .....	15
Clean Up the Dust Channel .....	15
<b>Troubleshooting</b> .....	<b>16</b>
<b>Frequently Asked Questions</b> .....	<b>18</b>
<b>Voice Prompts for Issues</b> .....	<b>19</b>
<b>Energy Saving Mode</b> .....	<b>20</b>

# IMPORTANT SAFETY INSTRUCTIONS

## READ ALL INSTRUCTIONS

### BEFORE USING THIS APPLIANCE

WARNING – To reduce the risk of fire, electric shock, or injury:

- Do not leave appliance when plugged in. Unplug from outlet when not in use and before servicing.
- Do not use outdoors or on wet surfaces.
- Do not allow to be used as a toy. Close attention is necessary when used by or near children.
- Use only as described in this manual. Use only manufacturer's recommended attachments.
- Do not use with damaged cord or plug. If appliance is not working as it should, has been dropped, damaged, left outdoors, or dropped into water, return it to a service center.
- Do not pull or carry by cord, use cord as a handle, close a door on cord, or pull cord around sharp edges or corners. Do not run appliance over cord. Keep cord away from heated surfaces.
- Do not unplug by pulling on cord. To unplug, grasp the plug, not the cord.
- Do not handle plug or appliance with wet hands.
- Do not use to pick up flammable or combustible liquids, such as gasoline, or use in areas where they may be present.
- Keep hair, loose clothing, fingers, and all parts of body away from openings and moving parts.
- Turn off all controls before unplugging.
- Do not put any object into openings. Do not use with any opening blocked; keep free of dust, lint, hair, and anything that may reduce air flow.
- Do not pick up anything that is burning or smoking, such as cigarettes, matches, or hot ashes.
- Do not use without dust bag and/or filters in place.
- Use extra care when cleaning on stairs.

WARNING: Do not charge non-rechargeable batteries.

WARNING: Read all safety warnings and instructions. Failure to follow the warnings and instructions may result in electric shock, fire and/or serious injury.

Risk of explosion. Floor sanding can result in an explosive mixture of fine dust and air. Use floor-sanding machine only in a well-ventilated area free from any flame or match.

- Prevent unintentional starting. Ensure the switch is in the off-position before connecting to battery pack, picking up or carrying the appliance. Carrying the appliance with your finger on the switch or energizing appliance that have the switch on invites accidents.
- Recharge only with the charger specified by the manufacturer. A charger that is suitable for one type of battery pack may create a risk of fire when used with another battery pack.
- Use appliances only with specifically designated battery packs. Use of any other battery packs may create a risk of injury and fire.

- Under abusive conditions, liquid may be ejected from the battery; avoid contact. If contact accidentally occurs, flush with water. If liquid contacts eyes, additionally seek medical help. Liquid ejected from the battery may cause irritation or burns.
- When battery pack is not in use, keep it away from other metal objects, like paper clips, coins, keys, nails, screws or other small metal objects, that can make a connection from one terminal to another. Shorting the battery terminals together may cause burns or a fire.
- Do not use a battery pack or appliance that is damaged or modified. Damaged or modified batteries may exhibit unpredictable behavior resulting in fire, explosion or risk of injury.
- Do not expose a battery pack or appliance to fire or excessive temperature. Exposure to fire or temperature above 130°C may cause explosion.
- Follow all charging instructions and do not charge the battery pack or appliance outside of the temperature range specified in the instructions. Charging improperly or at temperatures outside of the specified range may damage the battery and increase the risk of fire.
- Do not charge the battery at ambient temperature below 39°F (4°C) or above 104 °F (40°C). Also keeping the temperature range of between 39-104°F when storing unit or during use.
- Have servicing performed by a qualified repair person using only identical replacement parts. This will ensure that the safety of the product is maintained.
- Do not modify or attempt to repair the appliance except as indicated in the instructions for use and care.
- Place the cords from other appliances out of the area to be cleaned.
- Do not operate the vacuum in a room where an infant or child is sleeping.
- Do not operate the vacuum in an area where there are lit candles or fragile objects on the floor to be cleaned.
- Do not operate the vacuum in a room that has lit candles on furniture that the vacuum may accidentally hit or bump into.
- Do not allow children to sit on the vacuum.
- Do not use the vacuum on a wet surface.
- To reduce the risk of electric shock, this appliance has a polarized plug (one blade is wider than the other). This plug will fit in a polarized outlet only one way. If the plug does not fit fully in the outlet, reverse the plug. If it still does not fit, contact a qualified electrician to install the proper outlet. Do not change the plug in any way.
- Household use only
- The robot vacuum must only be supplied at safety extra-low voltage defined in the standard of EN 60335-1 corresponding to the marking on the charging dock. (for EU region)
- This charging dock can only charge lithium batteries and can only charge one battery at a time. The capacity of the battery does not exceed 2600mAh.

WARNING: Do not charge non-rechargeable batteries.

## SAVE THESE INSTRUCTIONS

**For Robot Vacuum:**

TP-Link hereby declares that the device is in compliance with the essential requirements and other relevant provisions of directives 2014/53/EU, 2009/125/EC, 2011 /65/EU and (EU) 2015/863. The original EU declaration of conformity may be found at <https://www.tapo.com/en/support/ce/>

TP-Link hereby declares that the device is in compliance with the essential requirements and other relevant provisions of the Radio Equipment Regulations 2017.

The original UK declaration of conformity may be found at <https://www.tapo.com/support/ukca/>

**Safety Information**

Keep the device away from water, fire, humidity or hot environments.

This appliance contains batteries that are only replaceable by skilled persons.

Do not attempt to disassemble, repair, or modify the device. If you need service, please contact us.

If the supply cord is damaged, it must be replaced by the manufacturer, its service agent or similarly qualified persons in order to avoid a hazard.

**Warning**

Avoid replacement of a battery with an incorrect type that can defeat a safeguard.

Avoid disposal of a battery into fire or a hot oven, or mechanically crushing or cutting of a battery, that can result in an explosion.

Do not leave a battery in an extremely high temperature surrounding environment that can result in an explosion or the leakage of flammable liquid or gas;

Do not leave a battery subjected to extremely low air pressure that may result in an explosion or the leakage of flammable liquid or gas.

Children should be supervised to ensure that they do not play with the appliance.

The appliance is only to be used with the charging station (Tapo RVD101) provided with the appliance.

The appliance contains a 2600mAh lithium-ion battery.

This appliance can be used by children aged from 8 years and above and persons with reduced physical, sensory or mental capabilities or lack of experience and knowledge if they have been given supervision or instruction concerning use of the appliance in a safe way and understand the hazards involved. Children shall not play with the appliance. Cleaning and user maintenance shall not be made by children without supervision.

Operating Temperature: 32 ~ 104°F (0 ~ 40°C)

Storage temperature: -4 ~ 140°F (-20 ~ 60°C)

When the battery is charged: 32 ~ 113°F (0 ~ 45°C)

**For Auto-Empty Dock / Battery:**

TP-Link hereby declares that the device is in compliance with the essential requirements and other relevant provisions of directives 2014/30/EU, 2014/35/EU, 2009/125/EC, 2011/65/EU and (EU)2015/863. The original EU declaration of conformity may be found at <https://www.tapo.com/en/support/ce/>

TP-Link hereby declares that the device is in compliance with the essential requirements and other relevant provisions of the Electromagnetic Compatibility Regulations 2016 and Electrical Equipment (Safety) Regulations 2016.

The original UK declaration of conformity may be found at <https://www.tapo.com/support/ukca/>

**For EU/UK Region**

Operating Frequency:

2400MHz~2483.5MHz / 20dBm (Wi-Fi)

2402MHz~2480MHz / 10dBm (Bluetooth)

TP-LINK CORPORATION PTE. LTD.

7 Temasek Boulevard #29-03 Suntec Tower One, Singapore 038987



# Package Contents

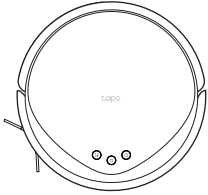

Robot Vacuum

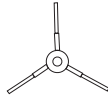

Side Brush ×1

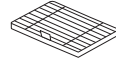

HEPA Filter ×1

\*One side brush and one HEPA Filter installed on the robot vacuum

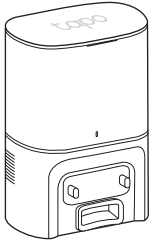

Auto-Empty Dock

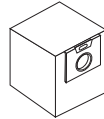

Dust Bag ×1

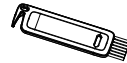

Cleaning Brush ×1

\*One dust bag and one cleaning brush placed inside the dock



Power Cord ×1

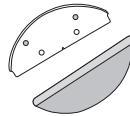

Mopping Attachment ×1

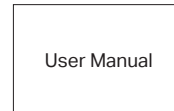

User Manual ×1

# Overview

## Robot Vacuum

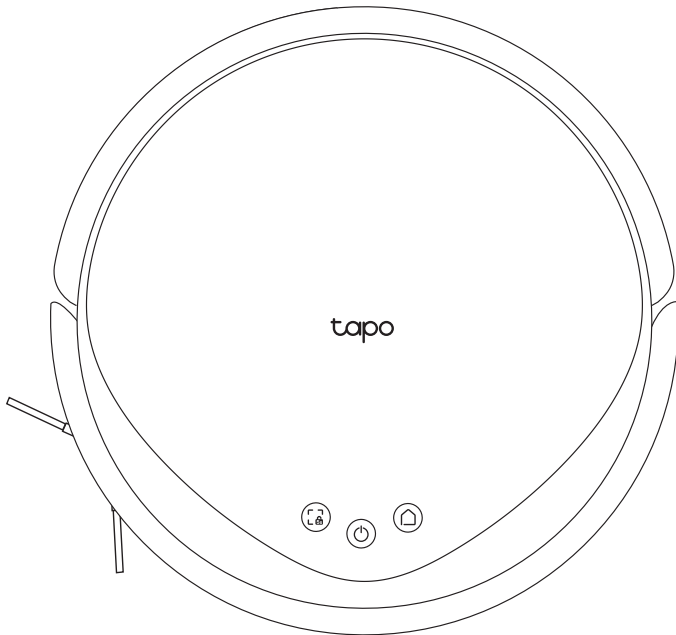

### Power/Clean

- Press and hold for 3 seconds: Turn on/off the robot vacuum.
- Press once: Start/pause cleaning.

### Dock

- Return to the dock to charge.
- Empty the dustbin when docked.

### Spot Cleaning/Child Lock

- Press once: Start spot cleaning.
- Press and hold for 5 seconds: Turn on/off the child lock.

### + Combo Button

- Press and hold simultaneously for 5 seconds:  
Enter setup mode to configure the network.
- Press and hold simultaneously for 10 seconds:  
Restore to factory default settings.

### LED

- **Red:** Battery level < 20%; Error
- **Orange:** Battery level between 20% and 80%
- **Green:** Battery level > 80%



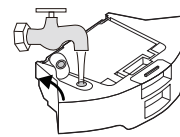
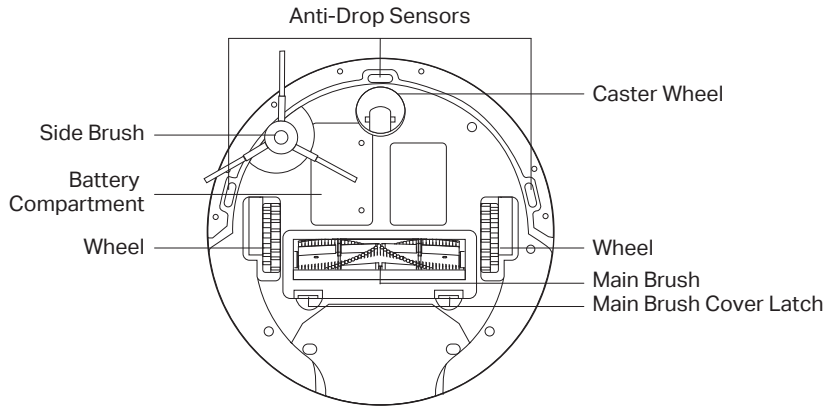
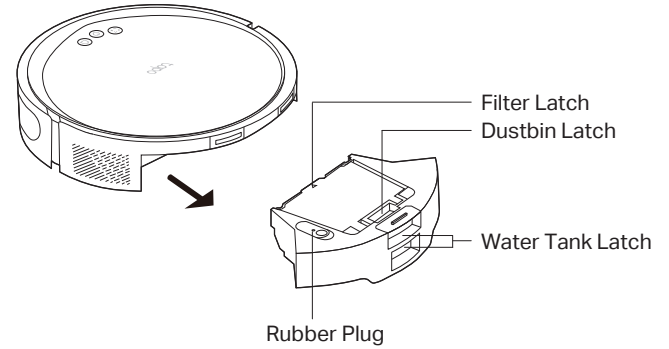
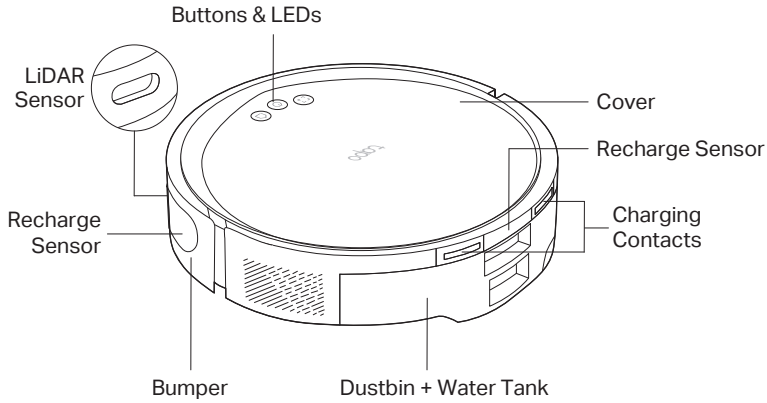

Add Water

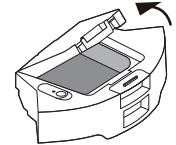

Open Dustbin



Do NOT add any cleaning agents.  
Wipe the water tank dry after adding water.

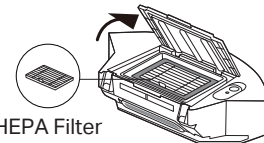

Open Lid

# Overview

## Auto-Empty Dock

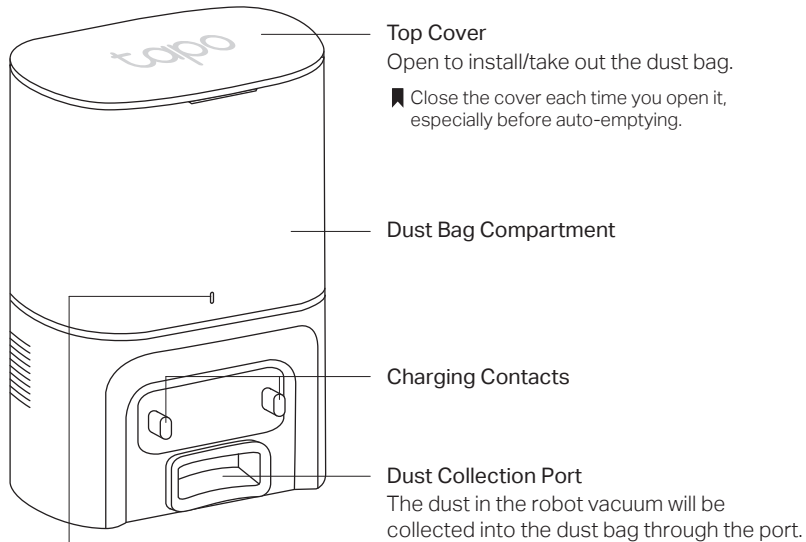

- LED Indicator**
- **White:** Working properly
  - **Pulsing White:** Charging the robot vacuum
  - **Flashing White:** Dust bag not installed or something wrong with the dust channel

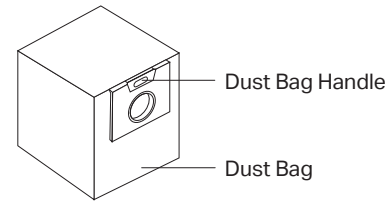

# 1 Position the Dock

1. Position the dock on a hard, level surface against a wall, ensuring 1.5m (4.9ft) of clear space in front and 0.5m (1.6ft) to the left and right.
2. Connect the power cord to the dock and power source. Keep the cable tidy.

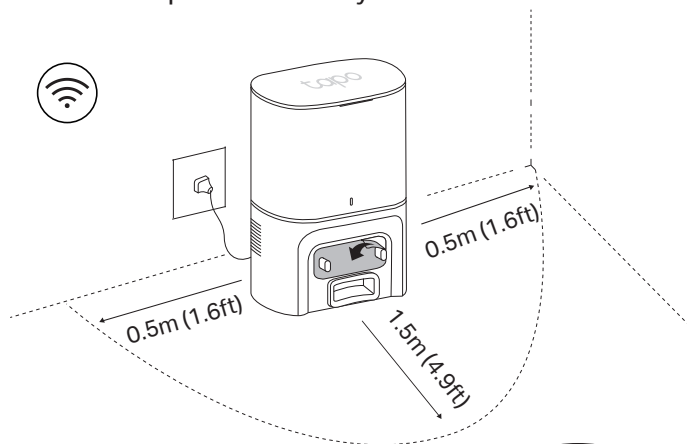

## Notes

- Route the power cable on the back of the dock.
- Peel off the protective film for optimal performance.
- Make sure the area receives good Wi-Fi signals.
- When the dock is powered on, the LED on the dock stays solid white.
- Always keep the dock powered on; otherwise, the robot vacuum will not automatically return. Do not move the dock frequently.

## Important Tips

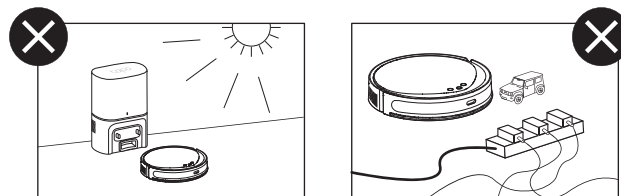

1

2

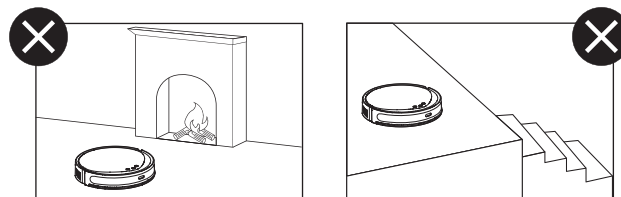

3

4

1. Avoid direct sunlight to ensure optimal performance and precise cleaning.
2. Remove power cords and small objects from the floor.
3. Place physical barriers in front of fireplaces and air vents that may damage the robot vacuum.
4. Anti-drop sensors are less effective if dirty or used on carpeted or dark-colored floors. Try setting block zones in the Tapo app after setup to prevent falls.

## 2 Remove Protective Film & Protective Strips

Remove the protective film and protective strips of the front bumper.

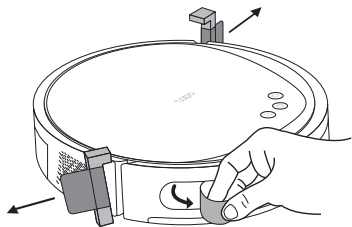

## 3 Turn On Robot Vacuum

Press and hold  for 3 seconds to turn on the robot vacuum. You will hear either "Turning On" or a beep, indicating a successful power-on.

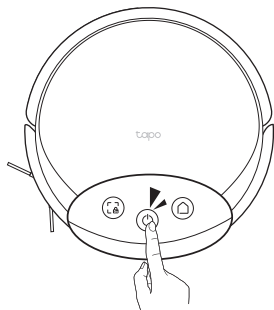

## 4 Charge Robot Vacuum

Place the robot vacuum on the charging dock or tap  to send it back to the dock to charge. It will return to the dock at the end of a cleaning job and whenever it needs to recharge.

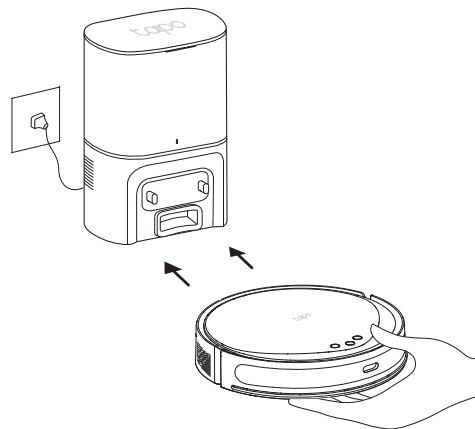

### Notes

- When you place the robot vacuum on the charging dock, the robot vacuum will turn on automatically.
- When the LED of the charging dock flashes 3 times, the charging will begin.
- We recommend that you fully charge the robot vacuum for about 4 hours prior to starting the first cleaning job.

## 5 Download the Tapo App and Connect to Wi-Fi

1. Download the Tapo app from the App Store or Google Play, then log in.



2. Open the Tapo app, tap the ⊕ icon, and select your model. Follow the step-by-step instructions to set up your robot vacuum and connect to your home Wi-Fi.

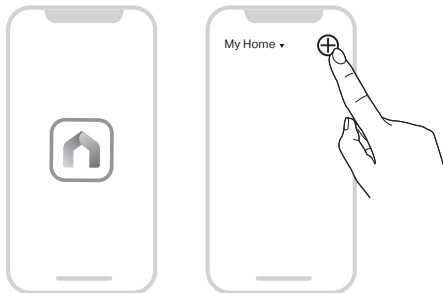



In the Tapo app, you can enjoy the following features.

- **Smart Maps**  
Start quick mapping and create smart maps of your home to tell your robot vacuum where to clean.
- **Cleaning Modes & Preferences**  
Customize vacuum power, cleaning times, and cleaning areas.
- **Scheduled Cleaning**  
Set an automatic cleaning schedule, then the robot vacuum will clean automatically at the set time and return to the dock after cleaning.
- **Custom Zones, Carpet Areas, and Virtual Walls**  
Add block zones, carpet areas, and virtual walls to prevent access to certain areas and rooms.

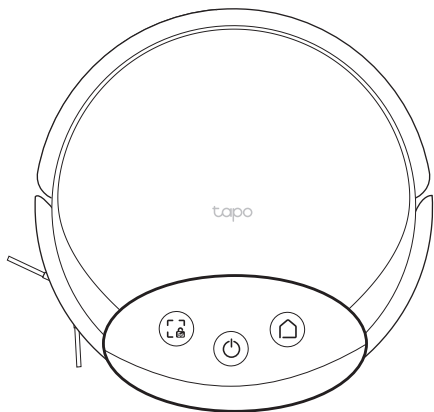
## 6 Cleaning



 **Press Once**  
Start/pause cleaning.

 **Press Once**  
Start spot cleaning.

### Notes

- Cleaning cannot start if the battery is too low. Charge your robot vacuum first.
- Before cleaning, remove power cords, small objects, and high-pile carpets from the floor.
- If the cleaning area is too small, the area may be cleaned twice.
- If the robot vacuum is paused for too long, it will automatically enter sleep mode. If the vacuum stays in sleep mode for 12 hours or if the battery level becomes too low, the cleaning job will be canceled.

The robot vacuum will automatically explore and clean your home in neat rows. It will return to the charging station at the end of a cleaning job and whenever it needs to recharge.

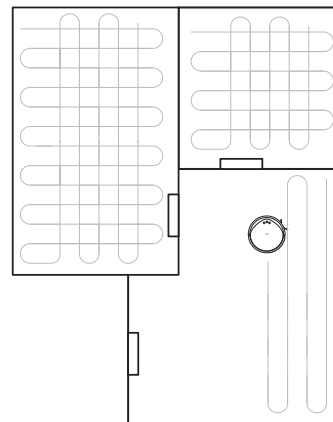

In Spot Cleaning mode, it will clean a rectangular area of 1.5m × 1.5m (4.9ft × 4.9ft) centered on itself. You can also customize the cleaning pattern in the Tapo app.

# 7 Mopping

1. Take out the dustbin and water tank.

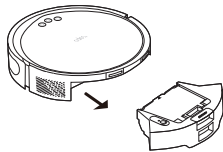

2. Remove the rubber plug and add water to the water tank.

 To prevent corrosion, do NOT add any cleaning agents. Only use cool or room temperature water and be careful not to wet the metal contacts.

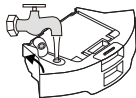

3. Wipe the water tank with a clean, dry cloth.

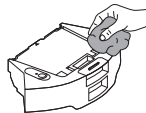

4. Install the washable mop cloth and the mop cloth mount.

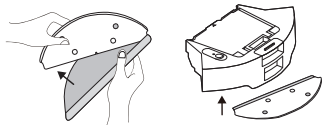

5. Re-install the dustbin and water tank.

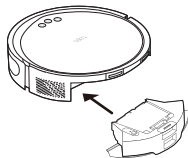

- Vacuum floors before starting the first mopping cycle.
- To prevent wetting the carpet, add a block zone, virtual wall, or carpet area on the Tapo app.
- The ability to cross obstacles is reduced when mopping.
- It is recommended to wash the mop cloth after each use.

1. Remove the mop cloth mount.

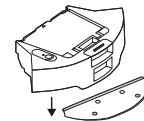

2. Remove the washable mop cloth.

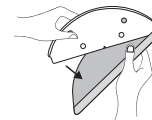

3. Clean the mop cloth.

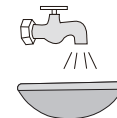

4. Sun dry the mop cloth and mop cloth mount.

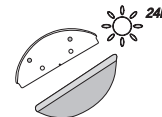

## 8 Care and Maintenance

To maintain optimal performance, maintain the robot vacuum according to the following guidelines.

Part	Maintenance Frequency	Replacement Frequency*
Dustbin	Clean/wash as needed	/
Filter	Once a week	3-6 months
Main Brush	Every 2 weeks	6-12 months
Main Brush Cover	Every 2 weeks	6-12 months
Side Brush	Once a month	3-6 months
Dust Bag	/	Replace when full
Mop Cloth	After each use	2-3 months
Caster Wheel	Clean as needed	/
Main Wheels	Once a month	/
Sensors	Once a month	/
Charging Contacts	Once a month	/

\*Replacement frequency may vary depending on the actual situation. Parts should be replaced if visible wear appears.



# Empty the Dustbin

## Option 1: Auto-Empty

It automatically empties the dustbin after cleaning. You can also press  on the robot vacuum when docked or tap the Empty button in the Tapo app to suck up dust and debris in the dustbin to the dust bag.

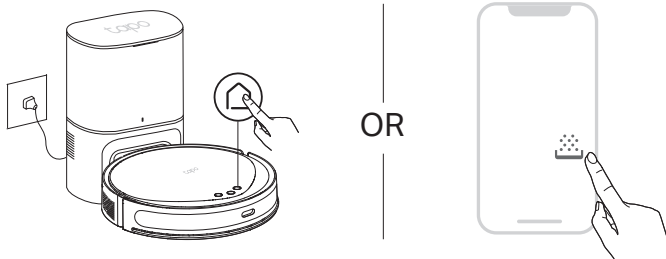

- 1. Remember to close the dock cover for auto-emptying.
- 2. Auto empty will not start until the robot vacuum has cleaned for more than 30 minutes in total.

## Option 2: Empty Manually

Remove and open the dustbin to empty the dustbin.

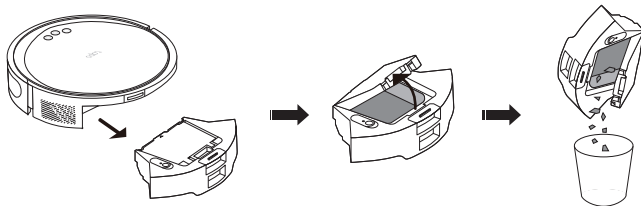

# Clean the Filter

1. Remove the dustbin and open the lid.

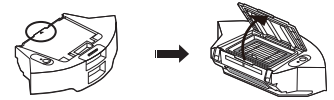

2. Remove the filter and clean the filter.

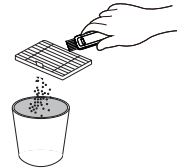

3. Wash the dustbin and filter.

Do not wash with hot water or detergents.

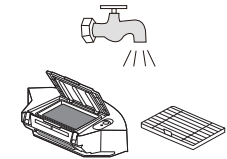

4. Air-dry the dustbin and filter thoroughly, then reinstall the filter as it was originally positioned.

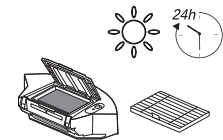

# Clean the Main Brush

1. Turn the robot vacuum over, then unlatch and remove the main brush cover.

■ If you have installed the mopping attachment, uninstall it from the robot vacuum first.

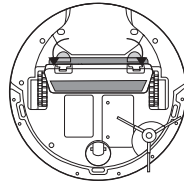

2. Remove the brush and its end cap.

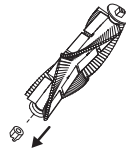

3. Remove any hair or debris with the cleaning brush.

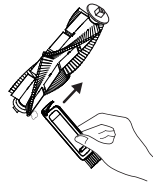

4. Reinstall the cap and main brush. Press on the main brush cover to lock it in place.

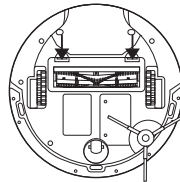

# Clean the Side Brush

1. Use a screwdriver to unscrew the side brush **clockwise**, remove debris, and wipe with a damp cloth if necessary.
2. Turn the side brush **anticlockwise** to secure it tightly and ensure it's properly installed.

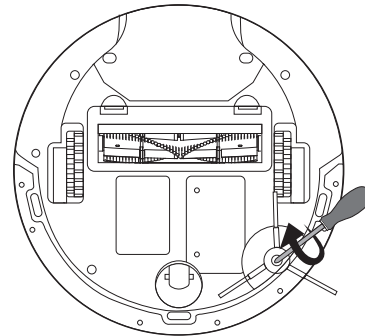

# Clean the Caster Wheel

1. Pull firmly to remove the caster wheel and remove hair or dirt.
2. Reinstall the caster wheel and press it firmly into place.

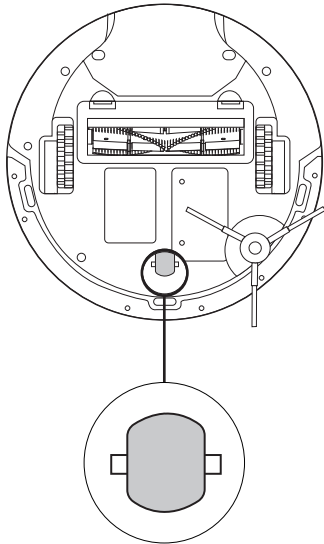

# Clean the Main Wheels

Wipe the main wheels with a clean, dry cloth.

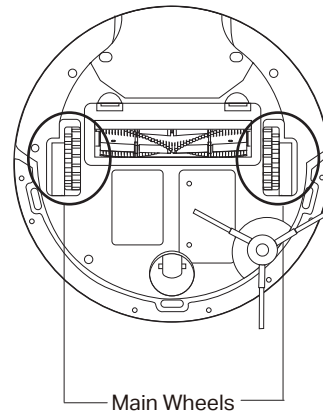

## Clean the LiDAR and Sensors

Wipe the LiDAR and sensors with a clean, dry cloth.  
Using a wet cloth may cause damage.

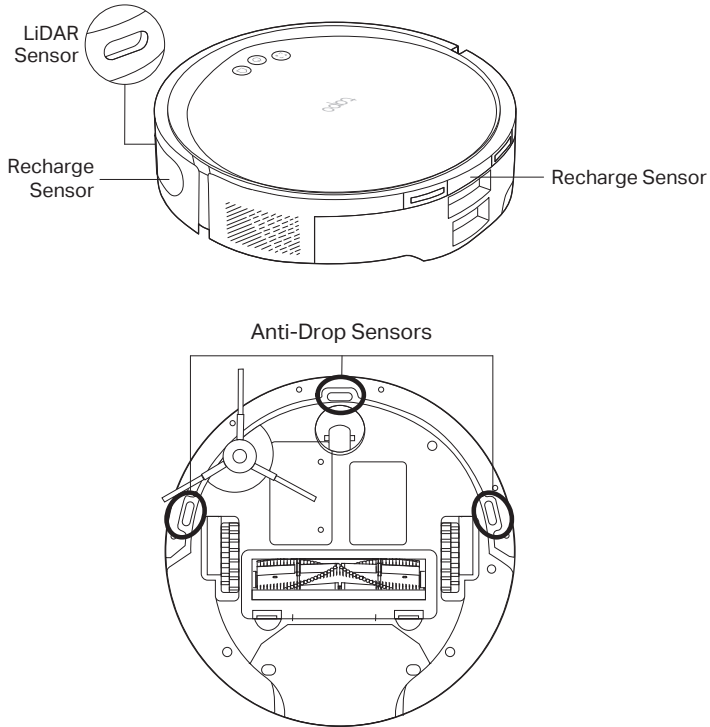

## Clean the Charging Contacts

Wipe the charging contacts with a clean, dry cloth.  
Using a wet cloth may cause damage.

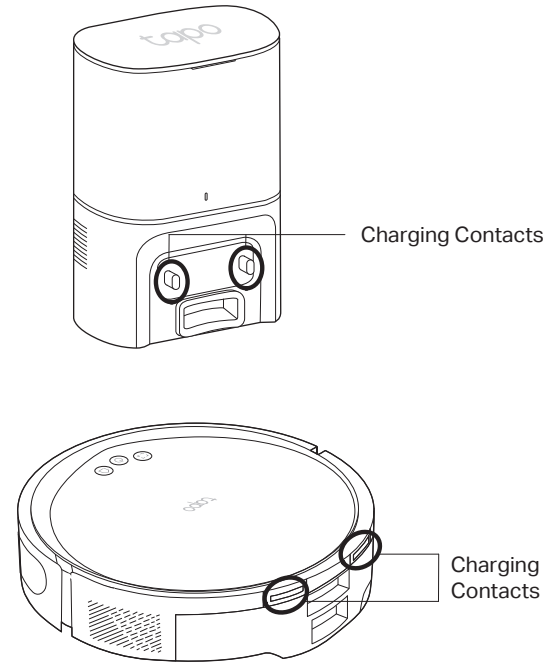

# Replace the Bag

1. Open the top cover and pull up the handle of the dust bag to remove.

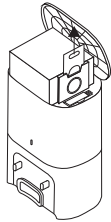

2. Throw away the used dust bag when it is full.

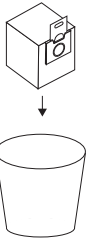

3. Install a new dust bag and put the cover back on.



Put the cover back on each time you open it, especially before auto-emptying.

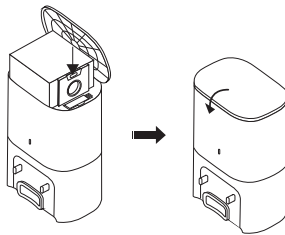

# Clean Up the Dust Channel



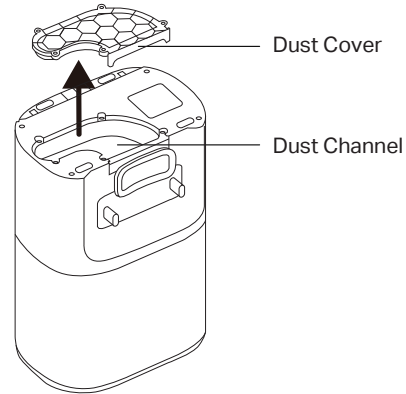



If the dust channel is blocked, use a screwdriver to remove its dust cover at the bottom and clear any foreign objects.





## 9 Troubleshooting



Scan for more

Issue	Solution
Setup failure	<ol style="list-style-type: none"><li>1. Check if the robot vacuum is turned on. If not, press and hold  for 3 seconds to turn it on.</li><li>2. The battery level is low. Please place the robot vacuum on the dock to charge, and the robot vacuum will turn on automatically when it is ready.</li></ol>
Failed to find the device in the Tapo app	<ol style="list-style-type: none"><li>1. Check if the robot vacuum is turned on. If not, press and hold  for 3 seconds to turn it on.</li><li>2. Ensure your phone/tablet's Bluetooth is turned on.</li><li>3. Move your phone/tablet closer to the robot vacuum.</li><li>4. Simultaneously press and hold  and  for more than 5 seconds to put your robot vacuum into setup mode, then try again.</li><li>5. If the problem persists, try using another phone or tablet to download the Tapo app and set it up again.</li></ol>
Failed to connect to Home Wi-Fi	<ol style="list-style-type: none"><li>1. Ensure your home Wi-Fi is a 2.4GHz network.</li><li>2. Ensure you have entered the correct Wi-Fi password.</li><li>3. The Wi-Fi signal may be too weak. Please move the robot vacuum closer to the router.</li><li>4. Simultaneously press and hold  and  for more than 5 seconds to put your robot vacuum into setup mode, then try again.</li><li>5. If the problem persists, try using another phone or tablet to download the Tapo app and set it up again.</li></ol>
Charging failure	<ol style="list-style-type: none"><li>1. Please check whether the LED of the dock is on and make sure that the power adapter of the dock is plugged in.</li><li>2. Poor contact. Please clean up the spring contacts on the dock and the charging contacts on the robot vacuum.</li></ol>
Recharge failure	<ol style="list-style-type: none"><li>1. Remove the protective film from the robot vacuum and dock before use.</li><li>2. Ensure that there are no foreign objects obstructing the bottom of the dock.</li><li>3. Ensure the robot vacuum starts cleaning from the dock every time and the map on the Tapo app shows the icon of the dock.</li><li>4. There may be many obstacles near the dock. Please check and place the dock in an open area.</li><li>5. The robot vacuum may be far from the dock. Please place the robot vacuum near the dock and try again.</li></ol>

Issue	Solution
Abnormal Noise	There may be foreign matter entangled in the main brush, side brush, or wheels. Please clean up after shutdown.
Poor Cleaning	<ol style="list-style-type: none"> <li>1. There may be too much dust on the floor. Please increase the vacuum power in the Tapo app and set two or more cleaning times.</li> <li>2. The dustbin may be full. Please tap the Empty button in the Tapo app or press  on the robot vacuum to empty the dustbin.</li> <li>3. The main brush may be entangled by foreign matter. Please check and clean the main brush.</li> <li>4. The filter may be clogged. Please clean or replace the filter.</li> </ol>
Schedule is not working	<ol style="list-style-type: none"> <li>1. The battery level may be low. Please charge the battery until it is above 20%.</li> <li>2. The cleaning is already in progress when the schedule starts.</li> <li>3. Check if Do Not Disturb is set in the Tapo app. Make sure the schedule is not within the set Do Not Disturb period.</li> <li>4. There is no internet access for your Wi-Fi network and your robot vacuum has restarted. Make sure your network has internet.</li> </ol>
Failed to automatically collect the dust	<ol style="list-style-type: none"> <li>1. Ensure the dock is powered on and you have closed the cover of the dock.</li> <li>2. Automatic dust collection will not start until the robot vacuum has cleaned for more than 30 minutes in total.</li> <li>3. Don't collect the dust again within 10 minutes.</li> <li>4. Check if Do Not Disturb is set in the Tapo app.</li> <li>5. Check if a dust bag is installed properly. If not installed or improperly installed, the dock LED will flash.</li> <li>6. Check if the dust bag is full and replace it.</li> </ol>
Offline	<ol style="list-style-type: none"> <li>1. Ensure the Tapo app and the robot vacuum firmware is up to date.</li> <li>2. Ensure the area receives good Wi-Fi signals.</li> <li>3. Ensure your router is working properly. Reboot the router and robot vacuum.</li> <li>4. Try to change the router's channel to 6, and width to 20MHz.</li> <li>5. Try to change the router's DNS to 8.8.8.8.</li> <li>6. If the robot vacuum does not respond, press and hold  for 5 seconds to force shutdown, then press and hold  for 3 seconds to turn it on and check.</li> </ol>



If the corresponding issues cannot be solved by referring to the above methods, please contact our Technical Support at <https://www.tp-link.com/support/contact-technical-support/>.



Scan for Support

## 10 Frequently Asked Questions (FAQ)



Scan for more

Question	Answer
How much time does it take to charge the robot vacuum?	It takes about 4 hours to fully charge the robot vacuum.
Can I add my preferred cleaning agents to the water tank?	No. The cleaning agents may corrode the water tank or affect the lifetime of your robot vacuum. Please add only water to the water tank.
Can the robot vacuum work on a wet surface?	The robot vacuum is not waterproof and should not operate on wet surfaces. Ensure you clean up any water in damp environments like bathrooms before use to prevent damage from liquids entering the robot vacuum.
What floor types does the robot vacuum support?	The robot vacuum can clean most floor types, such as hard floors, hardwood, tile, marble floors, carpet (not high-pile carpet), rugs, etc. For optimal performance, we recommend either removing high-pile carpets or setting specific carpet areas in the Tapo app.



If the corresponding issues cannot be solved by referring to the above methods, please contact our Technical Support at <https://www.tp-link.com/support/contact-technical-support/>.



Scan for Support



# 11 Voice Prompts for Issues

Voice Prompt	Solution
Error 1: Battery Error. Please refer to the manual or app.	The battery temperature is too high or too low. Please wait until the battery temperature changes to 0°C- 40°C (32°F- 104°F) .
Error 2: Wheel Module Error. Please refer to the manual or app.	Please check whether there are foreign objects stuck in the wheels, and restart the robot vacuum.
Error 3: Side Brush Error. Please refer to the manual or app.	Please check whether there are foreign objects stuck in the side brush, and restart the robot vacuum.
Error 4: Suction Fan Error. Please refer to the manual or app.	Please check whether there are foreign objects stuck in the fan port, and restart the robot vacuum. Please clean the dustbin and filter, and restart the robot vacuum.
Error 5: Main Brush Error. Please refer to the manual or app.	Remove the main brush, clean it, its connection, and its cover, as well as the dust suction port. Restart the robot vacuum after cleaning.
Error 6: Water Pump Error. Please refer to the manual or app.	Please clean the water tank, water pump connections on the tank and robot vacuum, the water outlet at the bottom of robot vacuum, and check the mop module. Then, try restarting the robot vacuum after cleaning.
Error 7: LiDAR Error. Please refer to the manual or app.	Please check whether there are foreign objects in the LiDAR sensor, and restart the robot vacuum after cleaning.





If the corresponding issues cannot be solved by referring to the above methods, please contact our Technical Support at <https://www.tp-link.com/support/contact-technical-support/>.



Scan for Support

# Energy Saving Mode

When the robot vacuum is docked, press and hold the Power button  and the Dock button  for more than 15 seconds until the LED turns off. It will then enter the Energy Saving mode.

In this mode, only the charging feature will be active. All other functions, including LEDs and sensors, will be disabled, and Wi-Fi will be disconnected.

To exit Energy Saving mode, press the Power button  on the robot vacuum; it will automatically revert to the Normal mode.





## **Need some help?**

Visit **[www.tapo.com/support/](http://www.tapo.com/support/)**

for technical support, user guides, FAQs, warranty & more

